

# Implementation of PV System with Two Inductor Buck Boost Converter

**T.Jeevanandham, M.Raja**

Paavai Engineering College, Namakkal  
 jeevarajee@gmail.com, mpare16@gmail.com

**Abstract:** *The project proposes a new converter for photovoltaic system which is substantially high performance oriented. Furthermore, the lack of batteries replacement water pumping systems without the use of chemicals are responsible for the failure of such systems in isolated areas. The converter is designed to drive a three-phase induction motor directly from photovoltaic system. The majority of commercial systems use low-voltage (PV) energy. The use of three-phase induction motor presents a suitable replacement of dc motor though by the use of dc motor we can directly drive by means of converter dc supply, but due to its lack of performance and reliability, we have opted for three phase induction motor. In the developed technique, there is no specialized personnel for operating and the system is based on a current-fed multi-resonant converter also maintaining these motors. Here, we make use of the TIBC topology such that they are found to be made of Buck Boost converter which will both stabilize and boost the output supply. Thus, the project will be a low cost high efficiency water supply duo for agricultural industry. Though solar energy based water supply system is being developed for the past 20 years, this project will be a phenomenal change and development of renewable energy that could be used in agricultural industry projects.*

**Index terms**–Solar power generation; Photovoltaic power systems; DC-DC power conversion; AC motor drives; DC-AC power conversion.

## I. Introduction

Renewable energy sources also called non-conventional type of energy are the sources which are continuously replenished by natural processes. Such as, solar energy, Bio-fuels grown sustainably, wind energy and hydropower etc., are some of the examples of renewable energy sources. A Renewable energy system convert the energy found in sunlight, falling water, wind, sea waves, geothermal heat, or biomass into an form, which we can use in the form of heat or electricity.

The majority of the renewable energy comes either directly or indirectly from sun and wind can never be fatigue, and therefore they are called renewable energy. However, the majority of the world’s energy sources come from conventional sources. Solar-powered pumping systems have been in use long enough that a preliminary assessment can be conducted related to their efficiency and cost compared to other alternative powered pumping systems. This preliminary assessment should be completed before deciding if solar power is the best source of alternative power for a village water supply system. Generally, alternative power is only considered when the cost of tapping into the closest public power grid far outweighs the costs of using alternative power. There are several technology

alternatives for supplying power or lift to groundwater systems including: wind turbines, windmills, generators, solar arrays, and hand powered pumps. The main driving factors for selecting the appropriate technology are regional feasibility, water demand, system efficiencies, and initial and long-term costs. Other factors often include the need for power and water reserves in the form of batteries and storage tanks. Solar-powered systems are often considered for use in developing countries instead of other forms of alternative energy because they are durable and exhibit long-term economic benefits.

## II. Proposed Converter

A photovoltaic system makes use of one or more solar panel electricity. It consists of various components which include the photovoltaic module, mechanical and electrical connections and mountings and means of regulating and/or modifying the electrical output. The Buck-Boost converter is a type of DC to DC converter that has an output voltage magnitude that is either greater than or less than the input voltage magnitude. The new topology makes use of the transformer leakage inductance and the switching device capacitance. The design is tolerant of transformer and output rectifier capacitance. Soft switching occurs for both the input switching devices and output diodes It presents a new isolated two-inductor buck boost converter. All magnetic components are integrated into one magnetic core. The circuit has the two inductor windings intrinsically coupled. The operation principle of the new circuit is presented.

The two-inductor, two-switch boost converter topology and its variations suitable for applications with a large difference between the input and output voltage are described. The output voltage regulation of the proposed converters is achieved in a wide load and input-voltage range with constant frequency control by employing an auxiliary transformer that couples the current paths of the two buck boost inductor

## Circuit Diagram

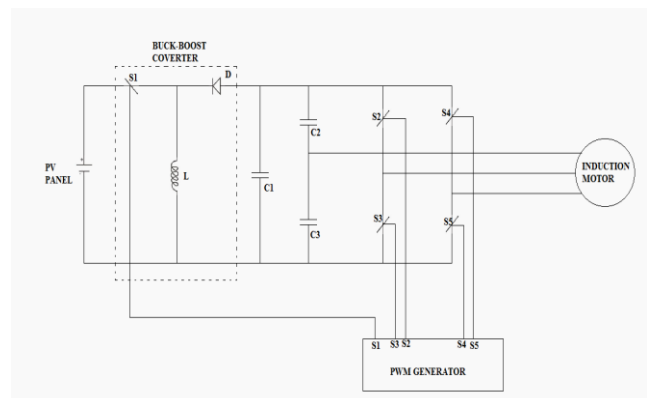

**Figure 1** Circuit Diagram of Proposed System

### Circuit Operation

The energy produced by the panel is fed to the motor through a converter.

Two power stages:

1. A DC/DC TIBC is used to boost the voltage of the panels
2. A DC/AC three-phase inverter to convert the DC voltage to three-phase AC voltage.
3. The regenerative snubber is formed by two diodes and a capacitor connecting the input side directly to the output side of the converter.
4. Three phase inverter from the output side is fed to the load and such that load pumps water through three phase induction motor.
5. The cooling system very prominent one here temperature is monitored according to which water get sprayed

To simplify the analyze of the proposed converter the following assumptions need to be true during a switching interval: the input inductors  $L_{i1}$  and  $L_{i2}$  in fig. 1 are sufficiently large so that their current is almost constant; the capacitors  $C_{o1}$ ,  $C_{o2}$  and  $C_s$  are large enough to maintain a constant voltage; the output capacitors  $C_{o1}$  and  $C_{o2}$  are much larger than  $C_r$ , to clamp the resonant voltage.

Classically the TIBC have a minimum operation load to maintain an established output voltage. Below a certain load level the energy transferred to the output capacitor is not completely transferred to the load and causes an increasing in the output voltage.

There are three main aspect in the proposed converter's control:

1. During normal operation a fixed duty cycle is used to control the TIBC MOSFETs, thus generating an unregulated high bus voltage for the inverter.
2. A MPPT algorithm is used along with a PI controller to set the speed of the motor and achieve the energy balance of the system at the maximum power point of the PV module.
3. A hysteresis controller is used during the no load conditions and start-up of the system.

### Two Inductor Based Buck Boost Converter

Two inductor buck boost converter for the first stage DC/DC converter is proposed, due to its very small number of components, simplicity, high efficiency, easy transformer flux balance, and common ground gate driving for both switches. These features make it the ideal choice for achieving the system's necessary characteristics. Beside the high DC voltage gain of the TIBC, it also compares favorably with other current-fed converters concerning switch.

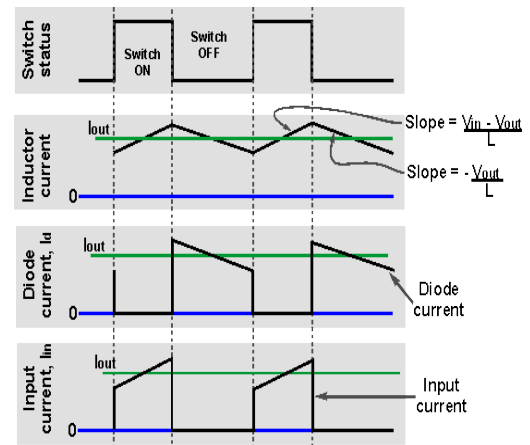

**Figure 2** key waveforms of two inductor buck boost converter

In its classical implementation the TIBC is a hard switched overlapped pulse modulated converter, this way at least one of the switches is always closed, creating a conduction path for the input inductors current. Nevertheless, the TIBC can be modified to a multi-resonant converter by adding a capacitor at the transformer's secondary winding. A multi-resonant tank is formed by the magnetizing inductance of the transformer, its leakage inductance and the added capacitor. The intrinsic winding capacitance of the transformer is included in the resonant capacitor.

Fig. 2 shows the wave forms produced during the operation of TIBC in circuit

### III. System Design

#### PV Panel

A photovoltaic system is an arrangement of components designed to supply usable electric power for a variety of purpose, using the Sun as the power source.

#### PV systems may be built in various configuration

1. Off-grid without battery (array-direct)
2. Off-grid with battery storage for DC-only appliances
3. Off-grid with battery storage for AC and DC appliances
4. Grid-tie without battery
5. Grid-tie with battery storage

A solar tracker tilts a solar panel throughout the day. Depending upon the type of tracking system, the panel was either aimed directly at the sun or the brightest area of a partly clouded sky. Tracker greatly enhance early morning and late afternoon performance, increase the total amount of power produced by a system by about 20–25% for a single axis tracker and about 30% or more for a dual axis tracker, depending on latitude. PV panel absorbs enough solar energy such that helps to perform the conversion of solar energy so as to perform dc voltage operation and dc supply is given to buck boost converter.

### Block Diagram

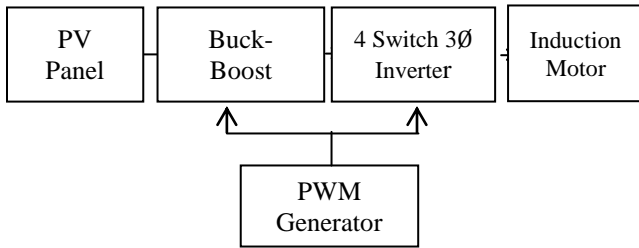

**Figure 3** Block Diagram of Proposed System

### Buck Boost Converter

The buck–boost converter is a type of DC-DC converter that has an output voltage magnitude that is either greater than or less than the input voltage magnitude. The two different topology are called buck–boost converter. Both of them produce a range of output voltages, from an output voltage much larger (in absolute magnitude) than the input voltage, lowered to almost zero.

A boost converter (step-up converter) is a DC-to-DC power converter with an output voltage greater than its input voltage. It is the class of switched-mode power supply (SMPS) containing at least two semiconductor switches (a diode and a transistor) and at least one energy storage element, capacitor, inductor, or the two in combination.

### Three Phase Inverter

Inverter, is an electronic device or circuitry that changes direct current (DC) to alternating current (AC). The input voltages, output voltage and frequency, and overall power handling, are dependent on the design of the specific device or circuitry.

A power inverter can be entirely electronic or may be a combination of mechanical effects (such as a rotary apparatus) and electronic circuitry. Static inverters do not use moving part in the conversion process.

Here six switches are being modified into four switches thus reducing the switching losses and also that four switches consists of two mosfets and also two capacitors thus helping for filtering and steady the supply.

### PWM Generator

Pulse-width modulation (PWM), or pulse-duration modulation (PDM), is a modulation technique that conforms the width of the pulse, formally the pulse duration, based upon modulator signal information. Although this modulation techniques can be used to encode information for transmission, its main use is to allow the control the power supplied to electrical device, especially to inertial loads such as motor. In addition, PWM is one of the two principal algorithms used in photovoltaic solar battery charger, the other being MPPT.

Three types of pulse-width modulation (PWM) are possible,

1. The pulse center may be fixed in the center of the time window and both edges of the pulse moved to compress or expand the width.
2. The lead edge can be held at the lead edge of the window and the tail edge modulated.
3. The tail edge can be fixed and the lead edge modulated.

### Induction Motor

In both induction and synchronous motors, the AC power supplied to the motor's stator creates a magnetic field that rotates in time with the AC oscillations. Whereas a synchronous motor's rotor turns at the same rate as the stator field, an induction motor's rotor rotates at a slower speed than the stator field. The induction motor stator's magnetic field is therefore changing or rotating relative to the rotor. This induces an opposing current in the induction motor's rotor, in effect the motor's secondary winding, when the latter is short-circuited or closed through external impedance.

The rotating magnetic flux induces currents in the windings of the rotor; in a manner similar to currents induced in a transformer's secondary winding(s). The currents in the rotor windings in turn create magnetic fields in the rotor that react against the stator field. Due to Lenz's Law, the direction of the magnetic field created will be such as to oppose the change in current through the rotor windings. The cause of induced current in the rotor windings is the rotating stator magnetic field, so to oppose the change in rotor-winding currents the rotor will start to rotate in the direction of the rotating stator magnetic field. The rotor accelerates until the magnitude of induced rotor current and torque balances the applied load. Since rotation at synchronous speed would result in no induced rotor current, an induction motor always operates slower than synchronous speed. The difference, or "slip," between actual and synchronous speed varies from about 0.5 to 5.0% for standard Design B torque curve induction motors. The induction machine's essential character is that it is created solely by induction instead of being separately excited as in synchronous or DC machines or being self-magnetized as in permanent magnet motors.

For rotor currents to be induced, the speed of the physical rotor must be lower than that of the stator's rotating magnetic field ( $n_s$ ); otherwise the magnetic field would not be moving relative to the rotor conductors and no currents would be induced. As the speed of the rotor drops below synchronous speed, the rotation rate of the magnetic field in the rotor increases, inducing more current in the windings and creating more torque.

### Water Pumping System

The system should be able to drive low power water pumps, in the range of 1/3 HP, more than enough to supply water for a family presents an overview of the proposed system. The energy produced by the panel is fed to the motor through a converter with two power stages: a DC/DC TIBC stage to boost the voltage of the panels and a DC/AC three-phase inverter to convert the DC voltage to three-phase AC voltage. The inverter is based on a classic topology (three legs, two switches per leg) and uses a sinusoidal pulse width modulation (SPWM) strategy with 1/6 optimal third harmonic voltage injection as proposed in . The use of this PWM strategy is to improve the output voltage level as compared to sinusoidal PWM modulation. This is a usual topology and further analyses on this topology are not necessary. For the prototype used to verify the proposed system, a careful selection of the VSI components is more than enough to guarantee the efficiency and cost requirements. Pumps

designed specifically for solar power utilize direct current (DC) and tend to be very energy efficient, but they usually cost more than their otherwise equivalent alternating current (AC) pump. Surface mounted pumps can be used for a SPSS, but are discouraged because of their suction limitations when used in deep wells compared to the achievable lift of a submersible pump. Based on the specifications from several manufactures such as Shurflow, Gaiam, and Dankoff, the typical suction abilities for surface pumps designed for solar power are between 10 and 20 feet. Surface pumps also have greater exposure to the climate making them more vulnerable to freezing and harsh weather. Submersible pumps are more protected from the climate and use the groundwater as a natural priming fluid.

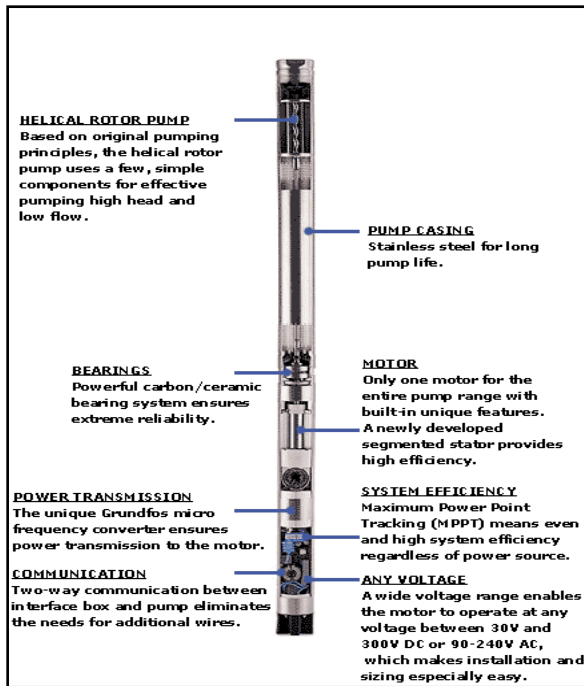

Figure 4 Pump parameters and specifications

### Maximum Power Point Tracking

Maximum power point tracking referred to as MPPT, an electronic system. MPPT is an essential part of PV system. It operates in a manner such that it optimizes the power generated by the power generated.

Since MPPT maximum available power. As the output of PV system are dependent on the temperature radiation, and the load characteristic MPPT cannot deliver the output voltage perfectly. For this reason MPPT is required to be implement in the PV system to maximize the PV array output voltage.

### Necessity of Maximum Power Point Tracking

In the power versus voltage curve of a PV module there exists a single maxima of power, i.e. There exists a peak power corresponding to a particular voltage and current. The efficiency of the solar PV module is low about 13%. Since the module efficiency is low it is desirable to operate the module at the peak power point so that the maximum power can be delivered to the load under varying temperature and radiation conditions. This maximized power helps to improve the use of the solar PV

module. A maximum power point tracker (MPPT) extracts maximum power from the PV module and transfers that power to the load. As an interfacing device DC/DC converter transfers this maximum power from the solar PV module to the load. By changing the duty cycles, the load impedance is varied and matched at the point of the peak power with the source so as to transfer the maximum power.

### Different MPPT Techniques

There exist several techniques for tracking the MPP of a photovoltaic array. These techniques are commonly referred to as MPPTs, maximum power point trackers. The choice of the algorithm depends on the time complexity, the algorithm takes to track the MPP, implementation cost and the ease of implementation.

Some MPPT approaches are explained below.

1. Perturb and Observe
2. Incremental Conductance method
3. Fractional short circuit current
4. Fractional open circuit voltage
5. Fuzzy logic

### Hill-Climbing Algorithm

Hill-climbing technique is the most popular MPPT methods due to their ease of implementation and good performance when the radiation is constant. The advantages of this method are the simplicity and low computational power they need. The shortcoming are also well known, oscillation around the MPP and they can get lost and track the MPP in the wrong direction during rapidly changing atmospheric conditions. This drawback is overcome by the neural network controller. The flow chart in the figure. 5 gives complete description of mppt and how current tracking happens in panel and the graphical form given in fig 6.

The P&O algorithm is also called “hill-climbing”, but both refer to the same algorithm depending on how it is implemented. Hill-climbing involves a perturbation on the duty cycle of the power converter and P&O a perturbation in the operating voltage of the DC link between the PV array and the power converter.

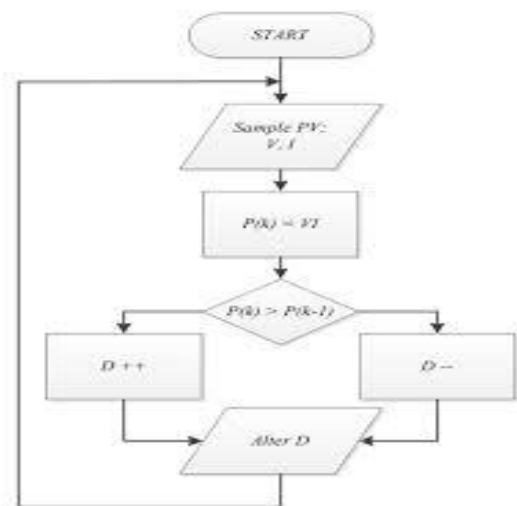

Figure 5 Flowchart for hill climbing technique

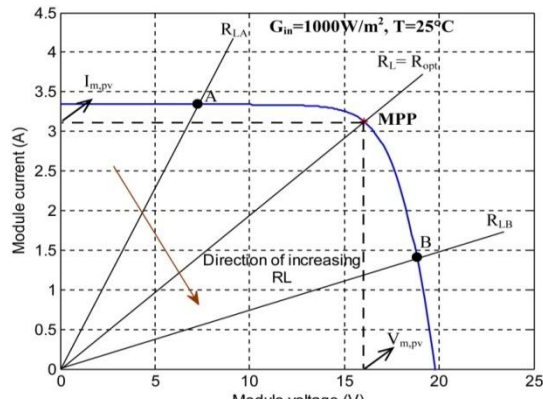

Figure 6 Graphical representation of mppt

#### IV. Simulation And Experimental Results

##### Input Voltage Waveform

Figure 7 shows the input voltage for the Buck boost converter which is obtained from the solar panel. The voltage obtained from the solar panel is changed due to the variation in the irradiation and the temperature.

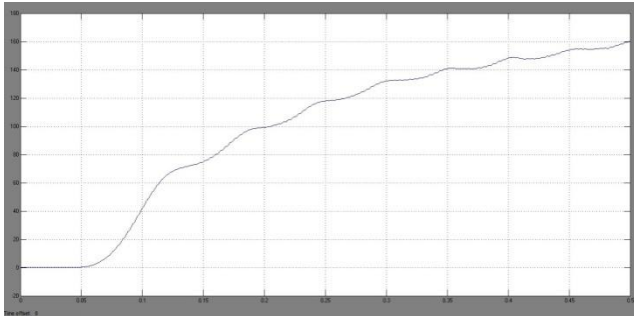

Figure 7 Input Voltage Waveform

##### Output Phase Voltage Waveforms

Figure 8 shows the output voltage waveform. The input of the buck boost converter is obtained from the solar panel. Based on the algorithm the duty cycle is produced and it was given to IGBT to produce the Boost output voltage. The output voltage is measured using a voltage measurement unit connected across the load and the output voltage is displayed via a scope.

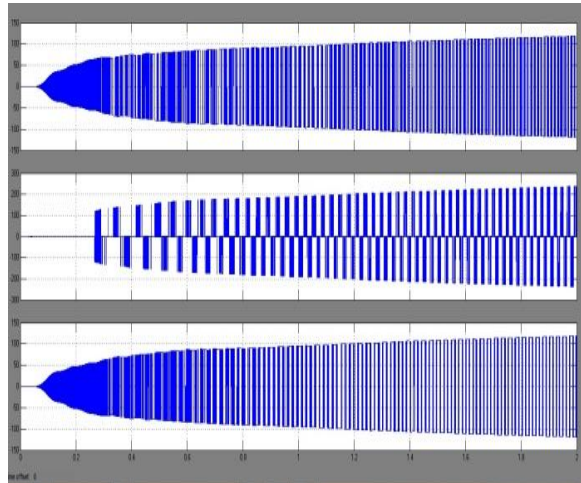

Figure 8 Output Phase Voltage Waveform

##### Output Current Waveform

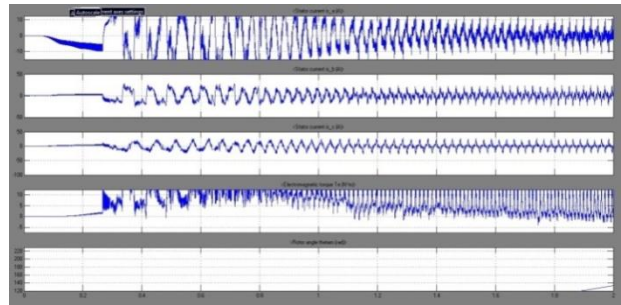

Figure 9 Output Current Waveforms

The output current wave form is shown in the figure 9. This current is obtained from the buck boost converter and the load is connected with this converter. The boost converter current is 1.5 amps, that is given to the load.

##### Output RPM Waveform

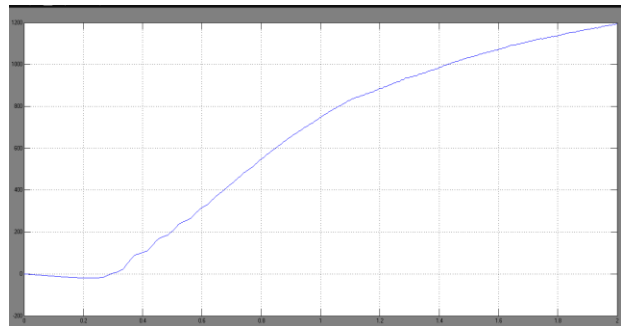

Figure 10 Output RPM Waveforms

Figure 10 shows that the maximum output RPM is obtained from the boost converter by the proposed MPPT algorithm. The maximum power is tracked accurately under the rapid irradiance variations and temperature variation.

Table 1 Comparison of the Proposed and Existing Method

Parameters	Proposed Method	Existing Method
Input Voltage(V)	160	150
Output RPM	1200	1000
Oscillations	High	Low

Table 1 gives the comparison of the proposed method and the existing method. The maximum power is tracked by the proposed method than the existing method. The oscillations are also reduced by the proposed algorithm.

#### V. Conclusion

In my project the battery is being replaced by converter, so as to reduce the cost and also to achieve higher precision of the operation. The system will very good option for agricultural industry. It is useful in extracting solar energy for a maximum amount. As agriculture is major backbone of our country is lack of electricity will give serious problems for supplying water to the field at the right time. Thus the challenging condition is tackled for this purpose our system will be an out and put remedy for facing the challenge.

The converter for PV water pumping treatment system, without the use of storage elements was presented. The converter was

designed to drive 3phase induction motor directly from PV solar energy. Here I have utilized the panel and the converter system for maximum efficiency performance and I have studied the partial amount of precision for the proposed system. From the system simulation it has been notified that the system is able to work at a efficiency of 90% for the development of the hardware system of our project is under processed.

## VI. References

- i. Montie A. Vitorino, Mauricio Beltrao R. Correa, (2009) "High Performance Photovoltaic Pumping System Using Induction Motor", In Proc. Brazilian Power Electronics Conference
- ii. G. Teröde, K. Hameyer and R. Belmans, "Sensorless Control of a Permanent Magnet Synchronous Motor for PV-powered Water Pump Systems Using the Extended Kalman Filter," in Ninth International Conference on Electrical Machines and Drives, pp. 366-370, 1999.
- iii. D. Tschanz, H. Lovatt, A. Vezzini, and V. Perrenoud, V., "A multi-functional converter for a reduced cost, solar powered, water pump," in, Proc. 2010 IEEE International Symposium on Industrial Electronics (ISIE), pp.568-572.
- iv. M. A. Vitorino, M.B.R. Correa, C.B. Jacobina, and A.M.N. Lima, "An Effective Induction Motor Control for Photovoltaic Pumping," IEEE Transactions on Industrial Electronics, vol. 58, pp. 1162 – 1170, April 2011.
- v. S. R. Bowes and A. Midoun, "Suboptimal switching strategies for microprocessor controlled PWM inverter drives," IEE Proceedings, vol. 132, Pt. B, pp. 133-148, May 1985.
- vi. M. Cacciato, A. Consoli, and V. Crisafulli, "A high voltage gain DC/DC converter for energy harvesting in single module photovoltaic applications," in Proc. 2010 IEEE International Symposium on Industrial Electronics (ISIE), , pp.550-555.
- vii. P. J. Wolfs, "A Current-Sourced Dc-Dc Converter Derived via the Duality Principle from the Half-Bridge Converter," IEEE Trans. Industrial Electronics, vol. 40, pp. 139-144, Feb. 1993.
- viii. P. Wolfs, and Quan Li; "An analysis of a resonant half bridge dual converter operating in continuous and discontinuous modes," in Proc. 2002 IEEE Power Electronics Specialists Conference, pp. 1313- 1318.
- ix. W. Li, L. Fan, Y. Zhao, X. He, D. Xu, and B. Wu, "High Step-Up and High Efficiency Fuel Cell Power Generation System with Active Clamp Flyback-Forward Converter," Industrial Electronics, IEEE Transactions on , vol. PP, no.99, pp.1, 2011.
- x. Tsorng-Juu Liang, Ren-Yi Chen, Jiann-Fuh Chen, and Wei-Jin Tzeng, "Buck-type current-fed push-pull converter with ZCS for high voltage applications," in Proc. 2007 IEEE Region 10 Conference, pp.1-4.
- xi. Ren-Yi Chen, Tsorng-Juu Liang, Jiann-Fuh Chen, Ray-Lee Lin, and Kuo-Ching Tseng, "Study and Implementation of a Current-Fed Full-Bridge Boost DC-DC Converter With Zero-Current Switching for High-Voltage Applications," IEEE Transactions on Industry Applications, vol. 44, pp. 1218-1226, Jul./Aug. 2008.
- xii. Jaehong Kim, Hong-Seok Song, Kwanghee Nam, "Asymmetric Duty Control of a Dual-Half-Bridge DC/DC Converter for Single-Phase Distributed Generators," IEEE Transaction on Power Electronics, vol. 26, pp. 973-982, Mar. 2011.
- xiii. L. Yan, and B. Lehman, "Isolated two-inductor boost converter with one magnetic core," in Proc. 2003 IEEE Applied Power Electronics Conference and Exposition, pp. 879- 885 .
- xiv. W. C. P. De Aragão Filho and I. Barbi, "A comparison between two current-fed push-pull dc-dc converters-analysis, design and experimentation," in Proc. IEEE INTELEC, pp. 313–320, 1996.
- xv. Quan Li, and P. Wolfs, "The Power Loss Optimization of a Current Fed ZVS Two-Inductor Boost Converter With a Resonant Transition Gate Drive," IEEE Transactions on Power Electronics, vol.21, pp.1253-1263, Sept. 2006.
- xvi. Bo Yuan, Xu Yang, Xiangjun Zeng, Jason Duan, Jerry Zhai, and Donghao Li, "Analysis and Design of a High Step-up Current-fed Multiresonant DC-DC Converter With Low Circulating Energy and Zero-Current Switching for All Active Switches," IEEE Transactions an Industrial Electronics, vol. 59, pp. 964-978, Feb. 2012.
- xvii. Yungtaek Jang, and M.M. Jovanovic, "New two-inductor boost converter with auxiliary transformer" in Proc. 2002 IEEE Applied Power Electronics Conference and Exposition, pp. 654 -660.
- xviii. Liang Yan, and B. Lehman, "Isolated two-inductor boost converter with one magnetic core," in Proc. 2003 IEEE Applied Power Electronics Conference and Exposition, pp. 879 -885.
- xix. R. Faranda, and S. Leva, "Energy comparison of MPPT techniques for PV Systems", WSEAS Transactions on Power Systems, vol. 3, pp. 446-455, June 2008.
- xx. P. M. Barbosa and I. Barbi, "A new current-fed, isolated PWM DC-DC converter," IEEE Trans. Power Electron., vol. 11, pp. 431-438, May 1996.